

LANCER

BEV85

OIL FREE AIR COMPRESSOR

230V / 50Hz

Installation, Operation & Service Manual



Table of contents

1. Specifications and Features	3
1.1 Model	3
1.2 Product Features	3
1.3 Specifications	3
1.4 Options	3
2. Safety Information	3
2.1 Safety Instructions	3
2.2 Recognise Safety Alert Symbols	4
2.3 Operating	4
2.4 Service & Maintenance	4
3. Environmental Recycle Responsibilities	5
3.1 Dispenser Disposal	5
4. Installation	5
4.1 Receiving	5
4.2 Unpacking	5
4.3 Selecting a Location	6
4.4 Mounting the BEV85 Compressor	6
4.5 Electrical Connection	7
4.6 Commissioning	7
5. Operation	7
5.1 Turn on	8
5.2 Adjust the Pressure	8
5.3 Turn off	8
6. Scheduled Maintenance	8
6.1 Weekly Maintenance	8
6.2 Quarterly Maintenance	9
6.3 Annual Maintenance	10
6.4 Auto Drain – Inspection & Testing	11
6.5 Regulator – Cleaning the water trap & filter	13
6.6 Air Filter Element – Cleaning & Replacement	13
6.7 Non-Return Valve (NRV)	14
6.8 Pressure Switch – Adjustment	15
7. Main Compressor Components	16
7.1 Spare Parts List	17
7.2 BEV85 Compressor Exploded Diagram	19
8. Trouble Shooting	20
9. Electrical Circuit Diagram	21
10. Certificate of Warranty	22
11. Installation Checklist & Warranty Form	23

1. Specifications and Features

1.1 Model

BEV85 Oil Free Air Compressor 80000157

1.2 Product Features

- Oil free operation
- Automatic Drain
- Certification of Suitability CS10728N to AS/NZS 60335.1
- Pressure Relief valve complying to AS1210
- 1500W / 2HP Copper Wound Motor
- Motor Overload Protection
- Heat Protection guards on Cylinder heads

1.3 Specifications

Voltage	230 Volts AC
Frequency	50 Hz
Max Run Current:	6.2 Amps
Power Lead:	10 Amp 3 pin plug with 1m lead
Rated Pressure:	8 Bar
Rated Volume	175 L/min Free Air Delivery (FAD) @ 100 PSI Pump Displacement 245 LPM @ 100 PSI
Motor rated:	1500W / 2HP
Sound Level:	52dBA with air filter
Motor Protection Class:	Motor Thermal Overload, Auto Reset Motor Winding Class 130C Copper Wound
Max Ambient Temperature:	40 deg. C
Assembled Weight:	38kg
Dimensions:	750mm (H) x 400mm (W) x 400mm (D) (420mm with bracket)
Regulated Air Outlets:	1 x tap with 10mm barb
Receiver Volume:	25L (Class 3, Hazard Level D – inspection not required under AS1210)
Auto Drain Connection:	8mm (5/16”) with converter to 3/8” barb

1.4 Options

Wall Mounting Bracket	80000203
Stand, Mount for 2 x BEV85	80000286

2. Safety Information

2.1 Safety Instructions

For your personal safety, and that of others working around you please read, understand, and follow thoroughly all safety instructions included in this manual and on the BEV85 Compressor.

- Review all applicable WHS (Work Health and Safety) regulations.
- Ensure that the BEV85 Compressor is maintained as per service manual instructions.
- Learn how to operate the BEV85 Compressor and use the controls properly.

- Do not allow untrained personnel to operate the machine.
- Do not allow any unauthorised modifications to the machine.
- Review all applicable Beverage Dispensing Gas Standards

2.2 Recognise Safety Alert Symbols

The safety alert symbol precedes Warning and Caution notes throughout this manual. To prevent personal injury or damage to the machine these alerts must be strictly adhered to.



Warning

Alerts to a potentially hazardous situation that if not avoided **CAN** result in death, serious injury.



Caution

Alerts to a potentially hazardous situation that if not avoided **MAY** result in injury or equipment damage.

2.3 Operating



Warning

The BEV85 Compressors are intended for indoor operation only; do not operate outside unless suitably protected by a weatherproof enclosure. This appliance is not suitable for installation in an area where a water jet could be used.



Warning

Compressed Air: use of appropriate PPE is required:

- Safety Glasses
- Gloves
- Protective Clothing



Caution

Unit may start unexpectedly



Caution

This appliance is not intended for use by persons (including children) with reduced physical, sensory or mental capabilities, or lack of experience and knowledge, unless they have been given supervision or instruction concerning use of the appliance by a person responsible for their safety. Children should be supervised to ensure that they do not play with the appliance.

2.4 Service & Maintenance



Caution

Installation of the BEV85 Compressor and service work should only be performed by approved service agents.



Warning

All wiring and plumbing must conform to local and national codes.

	Warning	Compressed Air: use of appropriate PPE is required: - Safety Glasses - Gloves - Protective Clothing	
	Warning	The BEV85 Compressor MUST be isolated from electrical supply before commencing any service or maintenance work.	
	Warning	HOT SURFACE. Do not touch. Wait for BEV85 compressor to cool down prior to any service work.	
	Caution	Do not manually operate the safety Pressure Switch to release pressure from the Storage Tank.	
	Warning	High pressure can cause severe injury. Shut off unit and taps. Vent all accumulators and lines before servicing this unit.	

3. Environmental Recycle Responsibilities

3.1 Dispenser Disposal

To prevent possible harm to the environment from improper disposal, recycle the unit by locating an authorised recycler to contact the retailer where the product was purchased. Comply with local regulations regarding disposal of the refrigerant, insulation and packaging materials.



4. Installation

	Warning	To avoid personal injury or damage, do not attempt to lift the BEV85 Compressor without help. Two person lift or the use of a mechanical lift is recommended. NOTE: BEV85 Compressor weight: 38kg.
--	----------------	--

4.1 Receiving

Each unit is completely tested under operating conditions and thoroughly inspected before shipment. At time of shipment, the carrier accepts the unit and any claim for damage(s) must be made with the carrier. Upon receiving units from the delivering carrier, carefully inspect shipping crate for visible indication(s) of damage. If damage exists, have carrier note damage on bill of landing and file a claim with the carrier.

4.2 Unpacking

Carefully unpack the BEV85 Compressor from the shipping carton.

Inspect unit for concealed damage and if evident, notify delivering carrier and file a claim against the carrier.

4.3 Selecting a Location

**Warning**

The BEV85 Compressors are intended for indoor operation only; do not operate outside unless suitably protected by a weatherproof enclosure.
This appliance is not suitable for installation in an area where a water jet could be used.
The BEV85 Compressors are not intended to be placed on a kitchen floor.

**Caution**

The BEV85 Compressor is only to be installed in locations where its use and maintenance is restricted to trained personnel.

- The BEV85 Compressor should be installed in a well-ventilated, level location, within 1m of a mains electrical supply and with easy access for servicing.
- Attach a drain hose (10mm inside diameter) to the auto-drain outlet connection on the BEV85 Compressor tank and discharge to the nearest drain tundish or floor waste drainage point. Note: Care must be taken not to create a slipping or tripping hazard through the auto-drain hose discharge.
- Ensure there is sufficient clearance around the BEV85 Compressor to allow good fresh air circulation.
- It is important that the air is clean, dust and oil free from the installation and should be away from water or wash down areas. Environment conditions will affect the service intervals and longevity of the unit.
- Installation should only be performed by a qualified and competent technician.

4.4 Mounting the BEV85 Compressor

**Caution**

The BEV85 Compressor operational weight is 38kg; ensure that all supporting structures are suitable for this load.
Supporting structure must be securely fixed to floor or walls.

- Place on a flat, stable, level surface.
- If the BEV85 Compressor is to be located inside a cool room it is recommended that the compressor is mounted at least 1.2 m off the floor.
- When wall mounted, use the optional wall mounting bracket 80000203.
- Ensure the fixing method is rated for the load and vibration of the BEV85 Compressor.
- Wall Bracket
 - Assemble 1 x rubber foot to back leg of compressor
 - Assemble 2 x rubber feet to front corners of wall bracket top cross channel (see picture)
 - Position bottom of wall bracket at recommended height of 1.2m above floor, check level, & mark mounting holes.
 - Drill mounting holes using appropriate PPE & securely fasten the wall bracket with suitable load rated wall fastenings
 - Use 2 person lift to lift Bev 85 and locate rear cross bar of handle into cross channel of wall bracket and also guide the rear leg/foot into cup at bottom of wall bracket
 - Gently lower Bev 85 until handle cross bar is securely located in wall bracket cross channel.
 - Confirm that Bev85 is securely mounted and retained in wall bracket, and that wall bracket is securely fastened to wall.



4.5 Electrical Connection

- It is recommended that the BEV85 Compressor is connected to a separate 230V AC 50Hz electrical supply, protected by an appropriate circuit breaker and Residual Current Device.
- Check the nameplate on the BEV85 Compressor for the electrical supply requirements.
- A licensed electrician may be required to ensure the installation is in accordance with the local codes and regulations.

**Warning**

To prevent possible electrical shock or extensive damage to the unit, the appliance must be connected with the flexible cord supplied to an appropriate electrical outlet socket installed in accordance with local codes and regulations i.e. AS/NZS 3000.

**Warning**

If the supply cord is damaged, it must be replaced by the manufacturer, its service agent, or similarly qualified persons with a replacement cord available from Hoshizaki Lancer Parts/Service Centres.

4.6 Commissioning

- Fit the rubber feet supplied to the 3 legs on the base of the BEV85 Compressor receiver tank.
- Confirm that the 2 air filter elements are installed in the housings, one on each compressor head.
- Install a 10mm inside diameter drainage hose to the auto drain outlet & discharge to nearest floor waste/tundish.
- Connect the airline to the isolation valve on the regulator outlet of the BEV85 Compressor.
- Complete electrical inspections & tagging in line with required regulations.
- Connect BEV85 Compressor power supply lead to an appropriate 3 pin socket outlet and switch on.

5. Operation

**Warning**

Do not point the discharged air from the BEV85 Compressor directly towards anybody or other animals.

**Caution**

This appliance is not intended for use by persons (including children) with reduced physical, sensory or mental capabilities, or lack of experience and knowledge, unless they have been given supervision or instruction concerning use of the appliance by a person responsible for their safety. Children should be supervised to ensure that they do not play with the appliance.

**Warning**

THIS LABEL INDICATES HOT SURFACES:
To avoid injury, do not touch any high temperature components of the BEV85 Compressor such as the cylinder head, exhaust pipe and one-way valve.



5.1 Turn on

- Connect the supply cord to appropriate power supply and turn on the supply, Turn ON the BEV85 Compressor by lifting the RED button on top of the pressure switch.
- The BEV85 Compressor motor will start and once it reaches the set pressure off the pressure switch, (approximately 1½ minutes) the compressor will cycle off.
- The pressure switch factory setting is 130psi (893kPa).
- The BEV85 Compressor is fitted with an automatic drain solenoid valve with an electronic timer. This removes condensation from the BEV85 Compressor receiver tank.
 - Press the "TEST" button featured on the auto drain timer module to discharge condensation manually and to check the auto-drain valve operates.



5.2 Adjust the Pressure

- The air pressure regulator is factory set to 90psi (620kPa).
- Adjust the output air supply pressure as required by:
 - Lifting & turning the knob on top of the regulator Clockwise to increase the output pressure. Push down knob to lock setting.
 - Lift & Turning the knob on top of the regulator Anti-Clockwise to decrease the output pressure. Push down knob to lock setting.



5.3 Turn off

- Turn off the BEV85 Compressor by pushing down the RED button on top of the pressure switch.

6. Scheduled Maintenance

Warning The BEV85 Compressor must not be cleaned by a water jet.

Warning The BEV85 Compressor MUST be isolated from the electrical supply and the receiver tank drained of air before commencing any service or maintenance work.

Warning Compressed Air: use of appropriate PPE is required:

- Safety Glasses
- Gloves
- Protective Clothing

The following routine maintenance should be performed on the BEV85 Compressor at the following intervals listed below:

6.1 Weekly Maintenance

- TURN OFF THE B85 COMPRESSOR: - Push down the RED button on top of the pressure switch and unplug the supply cord from the power supply.

Warning HOT SURFACE
Do not touch. Wait for BEV85 compressor to cool down prior to any service or maintenance work.

- **DRAIN THE AIR TANK**

Drain the air tank through the Drain Cock on the base of the receiver tank and monitor any moisture draining from the tank.

If there is an excessive amount of moisture, adjust the Auto Drain potentiometer to a more frequent or extended drain time.

**Caution**

Do not manually operate the safety Pressure Switch to release pressure (air) from the Storage Tank.

- **CHECK FILTER REGULATOR – Refer Section 6.5:**

Check the condition of the condensation bowl at the base of the Filter Regulator.

If the filter bowl is dirty, clean the filter bowl and brass element.

- **TURN ON THE BEV85 COMPRESSOR:**

Connect the power supply cord to the power supply and turn on, lift the RED button on top of the pressure switch.

- **CHECK FOR ANY AIR LEAKS:**

When the BEV85 Compressor is pressurised & idle there should be no air leaks. Monitor the tank pressure gauge, listen for leaking air (hissing) and/or use soapy water to inspect air fittings, pipe joints & connections.

If an air leak is detected have the compressor repaired by an approved service agent.

- **TEST THE AUTO DRAIN – Refer Section 6.4:**

Press the “TEST” button on the Auto Drain which should release a burst of air and then stop. If this does not work have the compressor checked by an approved service agent.

6.2 Quarterly Maintenance

**Caution**

Quarterly Maintenance on the BEV85 Compressor should only be performed by an approved service agent that has been fully trained on the servicing of the BEV85 Compressor.

**Warning**

Compressed Air: use of appropriate PPE is required:

- Safety Glasses
- Gloves
- Protective Clothing



- **TURN OFF THE B85 COMPRESSOR:** - Push down the RED button on top of the pressure switch, confirm the RED button functions correctly, ON (↑) / OFF (↓) and the black casing is not damaged and is firmly attached. Unplug the supply cord from the power supply.

**Warning****HOT SURFACE**

Do not touch. Wait for BEV85 compressor to cool down prior to any service or maintenance work.



- **DRAIN THE AIR TANK**

Drain the air tank through the Drain Cock on the base of the receiver tank and monitor any moisture draining from the tank.

If there is an excessive amount of moisture, adjust the Auto Drain potentiometer to a more frequent or extended drain time.

**Caution**

Do not manually operate the safety Pressure Switch to release pressure (air) from the Storage Tank.

- **CHECK AND CLEAN FILTER REGULATOR** – Refer Section 6.5:
Check the condition of the condensation bowl at the base of the Filter Regulator.
If the filter bowl is dirty, clean the filter bowl and brass element.
- **CHECK AND CLEAN AIR INLET FILTER** replace every 3 months where installed outside or in a humid, dusty, oily environment – Refer Section 6.6:
Turn the cap of the inlet filter assembly anticlockwise to release the protective cover, pull out the filter element and clean or replace as required.
- **CHECK THE NON-RETURN VALVE SEAL** – Refer Section 6.7:
Turn the nut on the Non-Return Valve anticlockwise to remove and expose the spring and seal. Clean the seal or replace if there are any major indentations or scarring on the seal surface.
- **TURN ON THE BEV85 COMPRESSOR:** - Connect the power supply cord to the power supply and turn on, lift the RED button on top of the pressure switch.
- **CHECK FOR ANY AIR LEAKS:**
When the BEV85 Compressor is pressurised & idle there should be no air leaks. Monitor the tank pressure gauge, listen for leaking air (hissing) and/or use soapy water to inspect air fittings, pipe joints & connections. Repair any air leaks that are detected.
- **CHECK THE NON-RETURN VALVE OPERATION** – Refer Section 6.7:
When the compressor reaches its cut-out pressure there should be a shot of air from underneath the pressure switch. If this shot of air is not evident or the air continually leaks replace the Non-Return Valve, Spring and Seal.
- **TEST THE AUTO DRAIN** – Refer Section 6.4:
Press the “TEST” button on the Auto Drain which should release a burst of air and then stop.
If a burst of air is not released then check the Auto Drain and repair or replace if necessary.

6.3 Annual Maintenance**Caution**

Annual Maintenance on the BEV85 Compressor should only be performed by an approved service agent that has been fully trained on the servicing of the BEV85 Compressor.

**Warning**

Compressed Air: use of appropriate PPE is required:

- Safety Glasses
- Gloves
- Protective Clothing



- **TURN OFF THE B85 COMPRESSOR:** - Push down the RED button on top of the pressure switch, confirm the RED button functions correctly, ON (↑) / OFF (↓) and the black casing is not damaged and is firmly attached.
Unplug the supply cord from the power supply.

**WARNING****HOT SURFACE**

Do not touch. Wait for BEV85 compressor to cool down prior to any service or maintenance work.



- **DRAIN THE AIR TANK**

Drain the air tank through the Drain Cock on the base of the receiver tank and monitor any moisture draining from the tank.

If there is an excessive amount of moisture, adjust the Auto Drain potentiometer to a more frequent or extended drain time.

**Caution**

Do not manually operate the safety Pressure Switch to release pressure (air) from the Storage Tank.

- **CLEAN THE FILTER REGULATOR – Refer Section 6.5:**

Clean the condensation filter bowl and brass element at the base of the Filter Regulator.

- **REPLACETHE INLET FILTERS – Refer Section 6.6:**

Turn the cap of the inlet filter assemblies anticlockwise to release the protective cover, remove the filter elements and replace with new filter elements.

- **REPLACE THE NON-RETURN VALVE SEAL AND SPRING – Refer Section 6.7:**

Turn the nut on the Non-Return Valve anticlockwise and remove the spring and seal and replace with new seal and spring.

- **REPLACE THE PISTON BARRELS AND THE PISTON SEALS (2 of).** Add glue (ie Loctite ® 222) to piston place screw and tighten.

- **TURN ON THE BEV85 COMPRESSOR:** - Connect the power supply cord to the power supply and turn on, lift the RED button on top of the pressure switch.

- **CHECK FOR ANY AIR LEAKS:** -

When the BEV85 Compressor is pressurised & idle there should be no air leaks. Monitor the tank pressure gauge, listen for leaking air (hissing) and/or use soapy water to inspect air fittings, pipe joints & connections. Repair any air leaks that are detected.

- **CHECK THE NON-RETURN VALVE OPERATION – Refer Section 6.7:**

When the compressor reaches its cut-out pressure there should be a shot of air from underneath the pressure switch. If this shot of air is not evident or the air continually leaks repair or replace the Non-Return Valve, Spring and Seal.

- **TEST THE AUTO DRAIN – Refer Section 6.4:**

Press the “TEST” button on the Auto Drain which should release a burst of air and then stop.

If a burst of air is not released then check the Auto Drain and repair or replace if necessary.

Replace rubber feet on Compressor if sitting on the ground and exposed to chemical cleaners.

ON LIGHT OFF LIGHT



6.4 Auto Drain – Inspection & Testing

**Warning**

The BEV85 Compressor **MUST** be isolated from the electrical supply and the receiver tank drained of air before commencing any service or maintenance work.

The BEV85 Compressor is fitted with an automatic drain solenoid valve with an electronic timer. The timer energizes the drain solenoid at set intervals for a set period of time removing condensation from the BEV85 Compressor receiving tank.

ELECTRONIC DRAIN TIMER

When the BEV85 Compressor motor is running the “OFF LIGHT” on the timer is illuminated, the drain solenoid is not energized.

At set intervals and for a set period of time the “ON LIGHT” on the timer is illuminated and the drain solenoid is energized.

TIME ADJUSTMENT

Right dial – Interval Time (0.5 to 45 mins)

Discharge time interval for the auto drain while compressor is running.

Factory Setting: 30 to 45 secs.

Left dial – Discharge Time (0.5 to 10 secs)

Length of time moisture is drain from the receiving tank at each interval.

Factory Setting: 2 secs.

LEFT DIAL RIGHT DIAL



TESTING

Pressing the “TEST” button on the Auto Drain should release a burst of air and then stop. The time period of the burst of air depends upon the setting on the left dial.

If a burst of air is not released then check the Auto Drain and repair or replace if necessary.

TEST BUTTON



6.5 Regulator – Cleaning the water trap & filter.



Warning

The BEV85 Compressor **MUST** be isolated from the electrical supply and the receiver tank drained of air before commencing any service or maintenance work.

PRESSURE ADJUSTMENT

The Regulator is used to set the working pressure of the BEV85 Compressor, and the water trap and filter reduces the amount of water and impurities in the compressed air supply. The regulator is factory set to 90psi (620kPa)

Adjust regulator pressure setting by lifting & turning the black knob:

- Clockwise to INCREASE compressor supply pressure.
- Anti-Clockwise to DECREASE compressor supply pressure.

The Gauge on the regulator shows the set pressure.

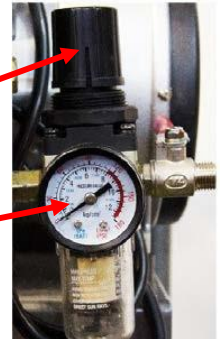

INSPECTION AND CLEANING

Remove the regulator bowl by turning clockwise and then pull down to remove. Inspect the condition of the regulator bowl, if dirty clean with warm water, if damaged replace bowl.

Turn the brass cartridge clockwise to loosen and remove it the from base of regulator clean it under warm water running water.

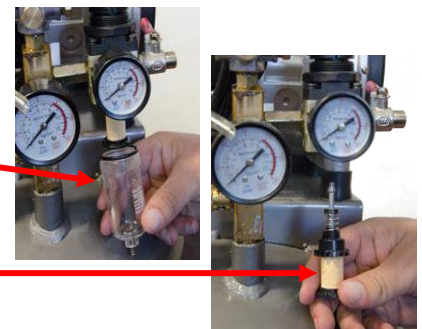

Soak and clean the filter in alcohol – to remove grime. Replace if unable to clean sufficiently or if damaged.

6.6 Air Filter Element – Cleaning & Replacement

Twist anticlockwise and pull on the filter casing cap to expose the filter element inside.

Inspect behind the filter element to ensure no element leakage.

If filter housing is dirty or oily, remove from head, and clean under warm water then dry before re-installation.

Clean the filter by tapping or dust off in opposite direction with compressed air. If required replace the filter.



6.7 Non-Return Valve (NRV)



Warning

The BEV85 Compressor **MUST** be isolated from the electrical supply and the receiver tank drained of air before commencing any service or maintenance work.

The Non-Return Valve (NRV) primary function is to stop the back pressure in the air receiver tank being forced back into the BEV85 Compressor pump.

The NRV 's other important function is to work in conjunction with the Pressure Switch and release the head pressure from the BEV85 Compressor pump when the Pressure Switch reaches its pre-set cut-out pressure. The failure to release this head pressure can cause capacitor or motor failure.

This function can be heard when the BEV85 Compressor reaches its cut-out pressure as a 'shot of air' from underneath the pressure switch. However, should this 'shot of air' not be evident, or the air continually leaks from underneath the pressure switch, it is commonly the NRV at fault and not the Pressure Switch.



Allow the BEV85 Compressor to cool, ensure the BEV85 Compressor is isolated from the power supply and that all air is released from the air receiver tank before commencing.

Use a correct size socket or spanner to unscrew the NRV cap.



Remove the NRV cap being careful not to lose the seal or spring housed inside. Please note orientation of the seal and spring.



Check the face of the seal making sure that there are no foreign objects present, or that the wear depression is not excessive. Wiping the face of the seal on a rag, can remove any objects from the seal; Do not use sand paper or a file on the face of the seal. Replace if necessary.



Place seal and spring in the correct orientation ensuring the spring sits correctly in the seal and NRV cap. Refit into NRV body and finger tighten the NRV cap. Do not over tighten.

6.8 Pressure Switch – Adjustment**Caution**

Adjustment to the pressure switch should only be completed with caution, please contact the manufacturer for clarification as required.

**Warning**

The BEV85 Compressor **MUST** be isolated from the electrical supply and the receiver tank drained of air before commencing any service or maintenance work.

CARE NEEDS TO BE TAKEN NOT TO OVER PRESSURIZE THE BEV85 COMPRESSOR.

There is risk of damage to the BEV85 Compressor and its components. (i.e. burnout of the pressure switch or activation of the safety relief valve on the spigot below the pressure switch).

- Isolate BEV85 Compressor from the electrical supply, unplug it.
- Remove the Pressure switch cover.
- Adjust in quarter turns only.
- Replace pressure switch cover and then reconnect to electrical supply.



To adjust the pressure switch pressure setting to a lower or higher value turn the bolt:

- Anti-clockwise towards the “-” negative symbol to decrease the pressure.
- Clockwise towards the “+” positive symbol to increase the pressure.
- Factory setting is 130psi (893kPa)







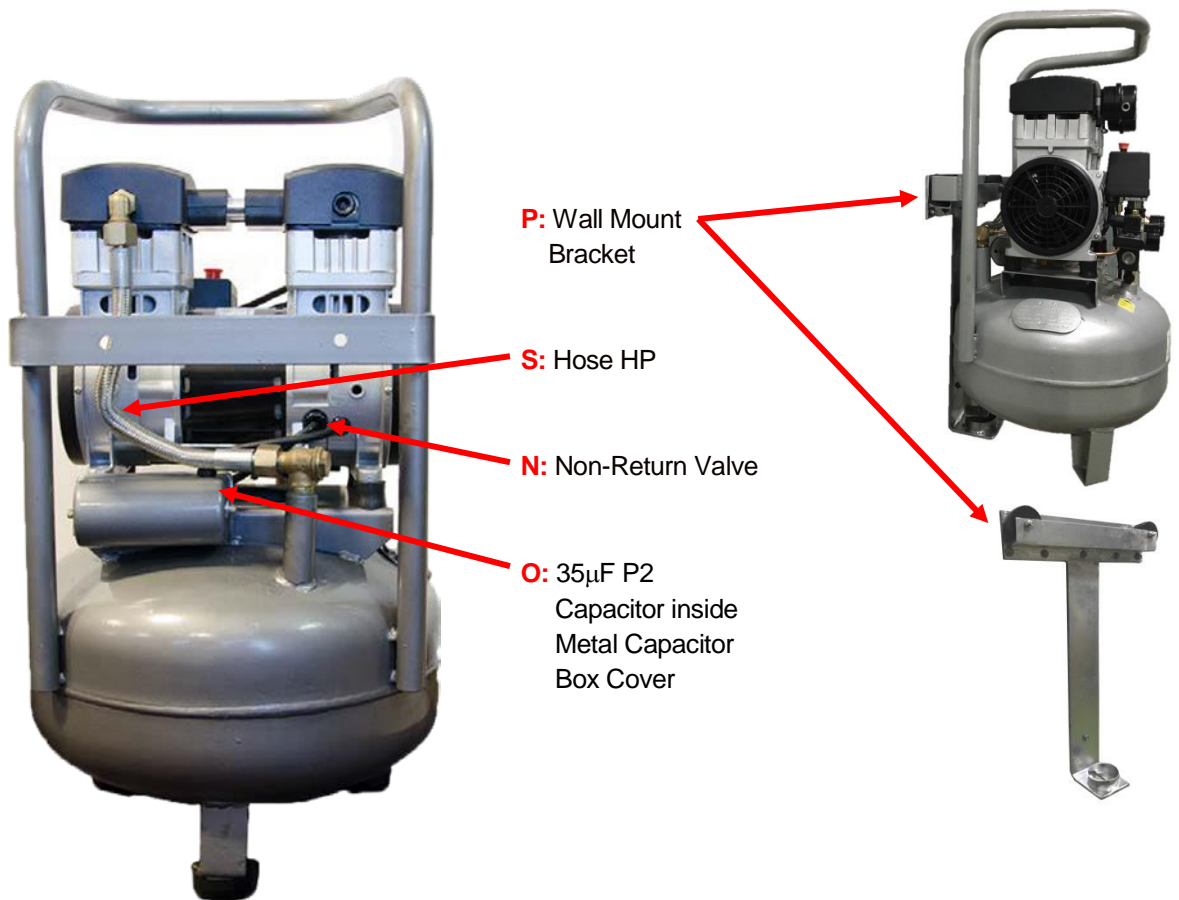
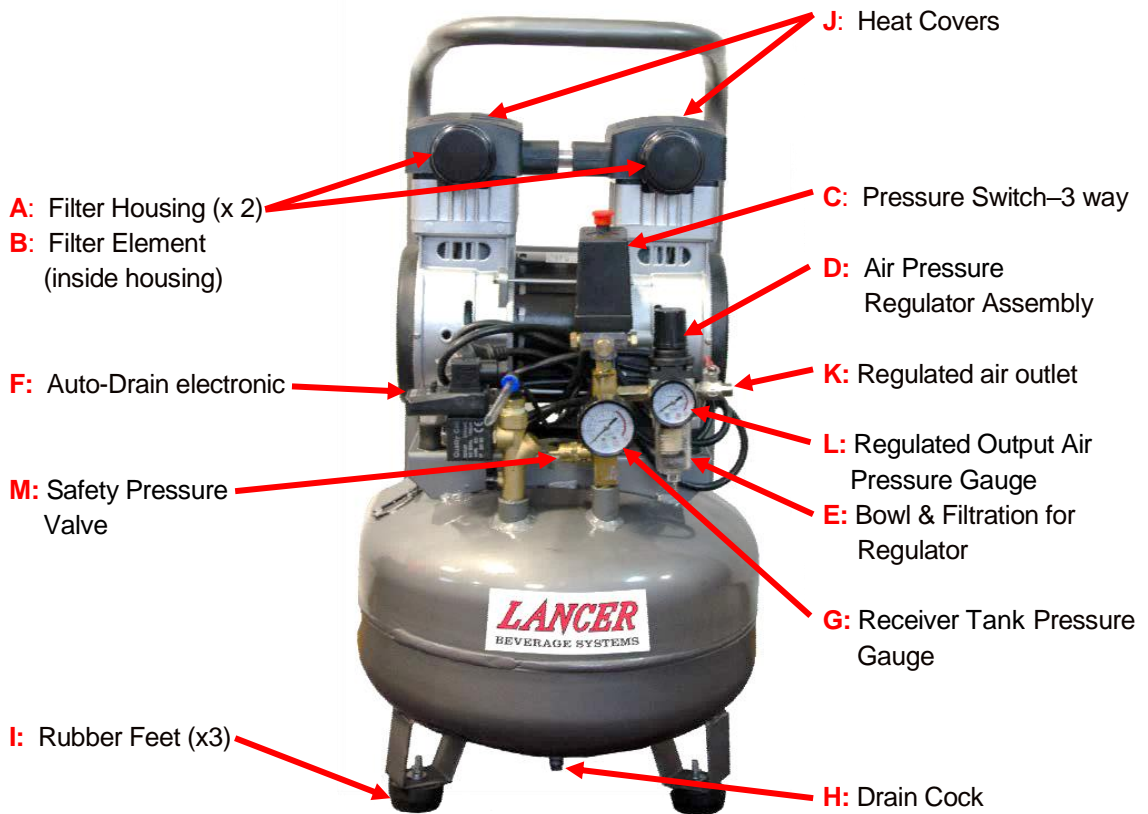



NOTE: ONLY MAKE SMALL ADJUSTMENTS i.e. 1/4 TURNS

7. Main Compressor Components



7.1 Spare Parts List

Part		Part Number	Description
A		80000238	Air filter housing
B		80000164	Air filter Element
C		80000207	Pressure Switch
		80000248	Pressure Switch - Diaphragm
D		80000230	Air Pressure Regulator with Bowl & Brass Filter Cartridge
E		80000229	Bowl & Brass Filter Cartridge
F		80000205	Auto Drain Assembly With - Drain Valve - Solenoid - Electronic timer - Plug
G		80000234	Receiver Tank Pressure Gauge
H		80000208	Drain Cock
I		80000209	Rubber Foot With bolt, nuts & washers
J		80000237	Heat Covers with screws

Part		Part Number	Description
K		80000240	Air Outlet Tap With 10mm barb outlet.
L		80000241	Regulated Air Output Pressure Gauge
M		80000242	Certified Safety Pressure Valve
N		80000247	Non-Return Valve With Spring & Seal
		80000228	Spring & Seal
O		80000236	35µF P2/S2 Capacitor
P		80000203	Wall Mount Bracket
-		80000286	Stand Only for 2 x BEV85 Air Compressors
Q		80000204	Annual Service Kit - Air filter cartridge x2 - Piston Ring x 2 - Piston Barrel x 2 - NRV Spring & Seal x1
R		80000239	Power Lead (1m)
S		80000217	Hose HP 1/2 BSPM x 300mm
-		80000250	Kit Spare Parts BEV85

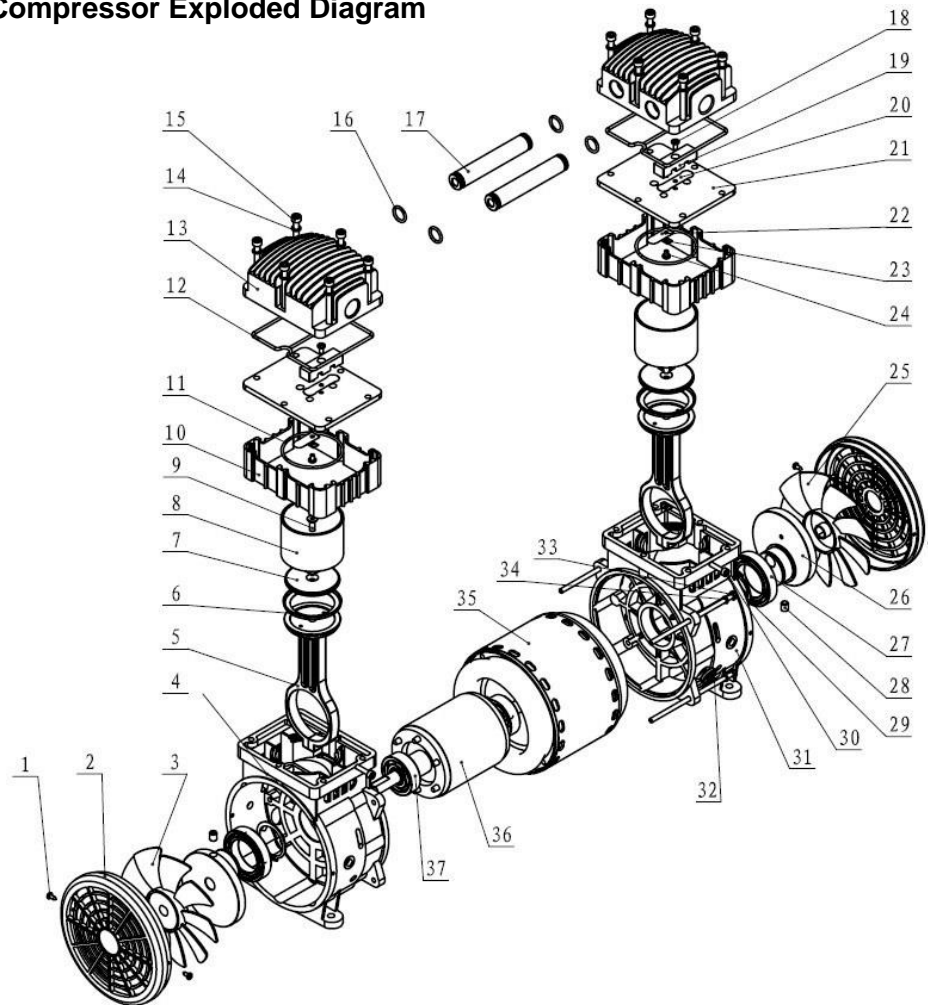
7.2 BEV85 Compressor Exploded Diagram

	Part Number	Description
1	80000213	Self-tapper 2.9x8
2	80000223	Fan Cover
3	80000221	Left Fan
4	215010101	Left Crankcase
5	2150101301	Con Rod
6	80000243	Piston Ring
7	80000245	Piston Ring Plate
8	80000244	Piston Cylinder
9	80000216	Piston Ring Plate Screw
10	215010104	Adjust Holder
11	80000211	Cylinder Seal
12	80000227	Cylinder head seal ring
13	80000224	Cylinder head
14	80000210	Spring Washer
15	80000214	Socket head cap screw
16	80000231	O ring (set of 4)
17	80000235	Cylinder connecting pipe
18	80000215	Valve Screw

	Part Number	Description
19	80000226	Fastening parts
20	80000232	Valve - Exhaust
21	80000225	Valve Plate
22	80000232	Valve - Intake
23	80000220	Metal Cushion
24	80000212	Screw
25	80000222	Right Fan
26	215010201	Crank
27	14039	Bearing 6908-2Z
28	70308	Screw
29	12809	Circlip
30	7020520	Screw
31	215010102	Right Crankcase
32	16403	Wire Protection
33	70905152	Screw
34	16602	Spring gasket
35	215010600	Stator
36	215010700	Rotor
37	14031	Bearing 6204-2Z

8. Trouble Shooting

Problem	Possible Cause(s)	Corrective Action
BEV85 Compressor will not run	<ol style="list-style-type: none"> No electrical power Blow fuse Breaker open Thermal overload open Pressure switch not working 	<ol style="list-style-type: none"> Plugged in? Check breaker Replace blown fuse Reset determining why problem happened Motor will restart when cool (approx. 15 minutes) Contact authorised service centre
No Air	<ol style="list-style-type: none"> No electrical power Air outlet tape turned OFF Regulator pressure set low Faulty regulator 	<ol style="list-style-type: none"> Plugged in? Check breaker Turn on tap Increase regulator pressure Replace regulator
Motor hums but cannot run or runs slowly	<ol style="list-style-type: none"> Low voltage Shortened or open motor winding Defective check valve or pressure switch Faulty Capacitor 	<ol style="list-style-type: none"> Check the supply voltage is between 216 & 254 volts Contact authorised service centre Contact authorised service centre Replace Capacitor
Circuit breaker trips repeatedly CAUTION! NEVER USE AN EXTENSION CORD WITH THIS PRODUCT	<ol style="list-style-type: none"> Circuit overloaded. Defective check valve or pressure switch 	<ol style="list-style-type: none"> Disconnect from other electrical appliances from circuit or operate BEV85 Compressor on its own branch circuit. Contact authorised service centre
Thermal overload protector cuts out repeatedly	<ol style="list-style-type: none"> Low voltage Clogged air filter Lack of proper ventilation / room temperature too high 	<ol style="list-style-type: none"> Check the supply voltage is between 216 & 254 volts Clean air filter (see maintenance section) Move BEV85 Compressor to well ventilated area
Tank pressure drops when BEV85 Compressor shuts off	<ol style="list-style-type: none"> Loose connection (fittings, tubing, etc.) Open drain cock Check valve leaking 	<ol style="list-style-type: none"> Check for air leaks. Use sealing tape on all leaking connections Tighten drain cock Disassemble check valve assembly. Clean or replace <p>DANGER! <i>DO NOT DISASSEMBLE CHECK VALVE WITH AIR IN TANK. BLEED TANK FIRST.</i></p>
Excessive moisture in discharge air	<ol style="list-style-type: none"> Excessive water in receiver tank High humidity Clogged intake filter 	<ol style="list-style-type: none"> Drain receiver tank Increase auto drain settings. Move BEV85 Compressor to area of less humidity; use airline filter Clean and replace filter
BEV85 Compressor runs continually	<ol style="list-style-type: none"> Defective pressure switch Excessive air usage Air leaks NRV not seating Compression rings or sleeves are worn. 	<ol style="list-style-type: none"> Replace switch BEV85 Compressor not large enough to meet CFM requirements for the air demands by equipment. Check & fix leaks Replace spring and seal in NRV Contact authorised service centre to replace rings & sleeves
BEV85 Compressor vibrates	<ol style="list-style-type: none"> Loose mounting bolts Rubber tank feet worn / missing BEV85 Compressor not level Piston Barrel misaligned 	<ol style="list-style-type: none"> Tighten Replace Reposition & level compressor Rebuild pistons
Air output lower than normal	<ol style="list-style-type: none"> Open drain cock Intake filter dirty Connection leaking Air leak from under pressure switch 	<ol style="list-style-type: none"> Tighten drain cock Clean or replace intake filter Tighten connections Replace spring and seal in NRV

9. Electrical Circuit Diagram

BEV85 BEVERAGE COMPRESSOR

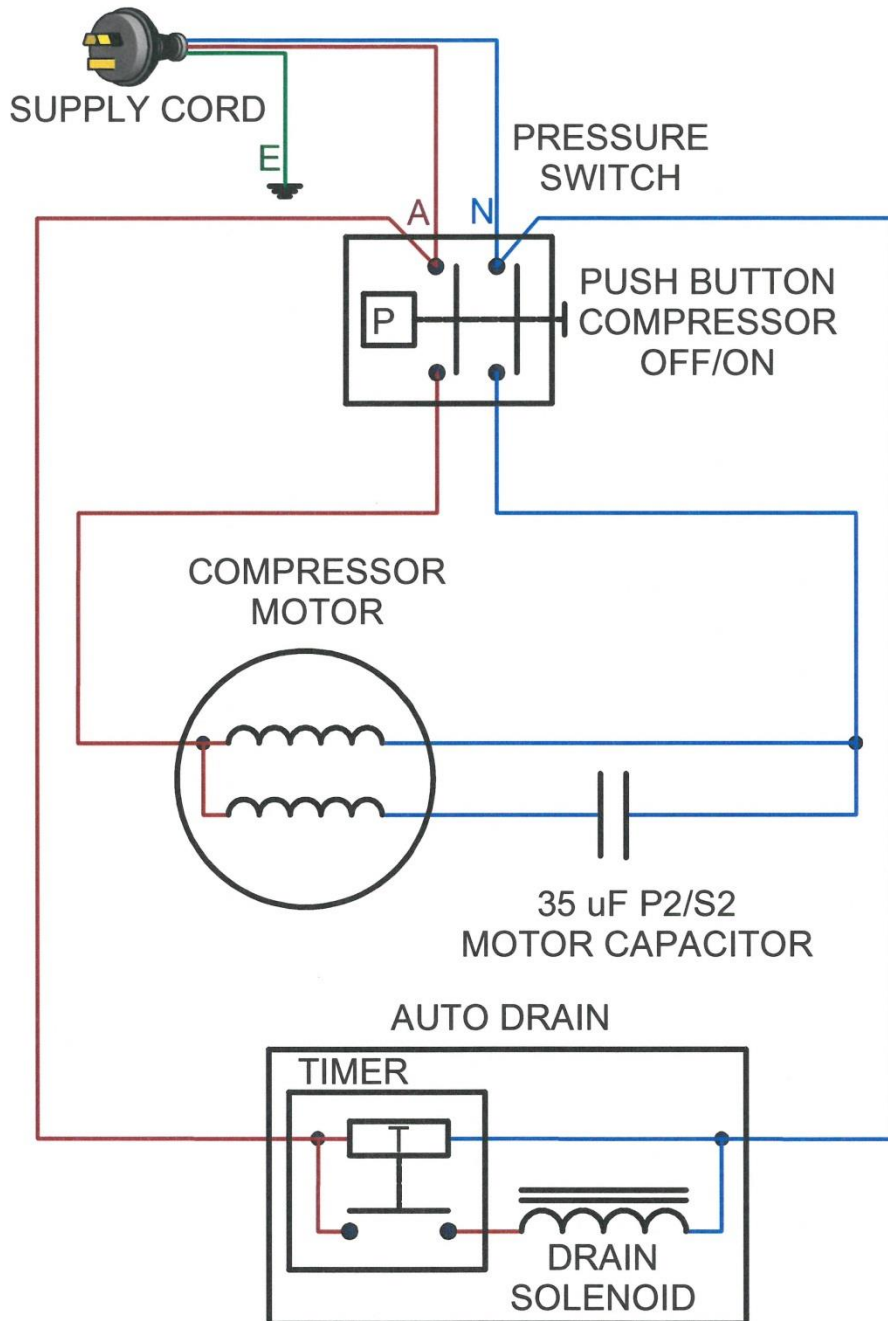

10. Certificate of Warranty

It is the policy of Hoshizaki to provide to its current customers, warranty for all equipment supplied and installation work performed within a specified period.

Parts and Equipment

Lancer provides a warranty period of twelve (12) months from the date of original invoice for all manufactured parts. Repair or replacement of defective parts will be at the sole discretion of Lancer.

Changeover parts will be invoiced to the customer at the customers normal purchase cost and upon return of the warranty item and validation of the claim, the invoice will be credited.

Installations

Lancer provides a warranty period of twelve (12) months from the date of final invoice for workmanship after the completion of any installation work, provided the parts and labour are completed by Lancer or its subcontractor.

Labour

Lancer will not normally cover any labour costs associated with a warranty claim. Subject to the approval of the Divisional Sales Manager, Lancer may choose to reimburse the customer for some or all labour costs associated with a warranty claim. Any claim for labour costs must be authorized by Lancer prior to the work being undertaken.

Exclusions

Lancer will not accept any liability or cost associated with any consequential losses (such as loss of syrup or beer), loss of profit or damage to property as a result of faulty product.

Warranty shall not apply:

- a) If in the opinion of Lancer, the equipment has been used in a situation the equipment has not been designed for;
- b) If in the opinion of Lancer, the equipment has been subject to abuse, negligence or accident;
- c) If connected to improper, inadequate or faulty power, water or drainage service or operated using incorrect, insufficient or contaminated lubricants, coolants, refrigerants or additives;
- d) Where the product is installed, maintained or operated otherwise than in accordance with the instructions supplied by Lancer;
- e) Where the product has been damaged by foreign objects;
- f) Where the product has been serviced, repaired, altered or moved otherwise than by Lancer or its nominees or using other than Lancer approved replacement parts.
- g) To the non-serviceable parts which are inclusive of but not limited to Piston Ring & Barrel, Non Return Valve Spring and Seal, Air Filtering elements and Rubber Feet.

To obtain full details of your warranty and approved service agency, please contact your dealer/supplier, or the nearest Hoshizaki Lancer Office.

Hoshizaki Lancer TEL: +61 8 8268 1388 FAX: +61 8 8268 1978



11. Installation Checklist & Warranty Form

Manufacturer Checklist

Machine No.:	Tank Serial No.:	Auto Drain Function Set	NRV Check	Check Elec. wiring:	Check 1/4" Safety Valve:	1/4" Safety Valve Serial No.:	Comp. Cycle Time:(mins.)	Date Checked	Checked by:
		Burst Time: Time Delay:							

Installer Checklist

Check Supply Point	No Air Leaks	Auto Drain Function Set	BEV85 Compressor Cycle Time (mins.)	Check Safety Valve (Is documentation attached to unit as per legal requirements?)	Air intake filter & Feet installed	Installation Date
Voltage: ____V Freq: ____HZ Protection Type:		Burst Time: Time Delay:				

INSTALLED AT:	INSTALLATION COMPANY:
INSTALLED ADDRESS:	INSTALLER NAME:
	CONTACT PHONE NUMBER:
	SIGNATURE:

MANUFACTURERS WARRANTY REGISTRATION

Once the Beverage BEV85 Compressor has been installed please send this form back completed along with proof of purchase to: equipment@lancerbeverage.com

Failure to register your Hoshizaki Lancer BEV85 Compressor will result in all warranty claims being denied.

Registration must be completed within 7 days of installation; any problems with Installation must be advised to Hoshizaki Lancer Service Department Immediately.

Hoshizaki Lancer will not accept any warranty claims unless they have been authorised prior through the Hoshizaki Lancer Service Department.

